

Montáž nábytku

Poznámka: Pred začatím montáže nábytku si prečítajte všetky pokyny na montáž vrátane pravidiel údržby a používania. Postupujte v jednotlivých fázach montáže podľa odsekov uvedených  vo Všeobecných pravidlách pre montáž nábytku.

USCHOVAJTE TENTO NÁVOD POČAS CELEJ DOBY POUŽÍVANIA NÁBYTKU.

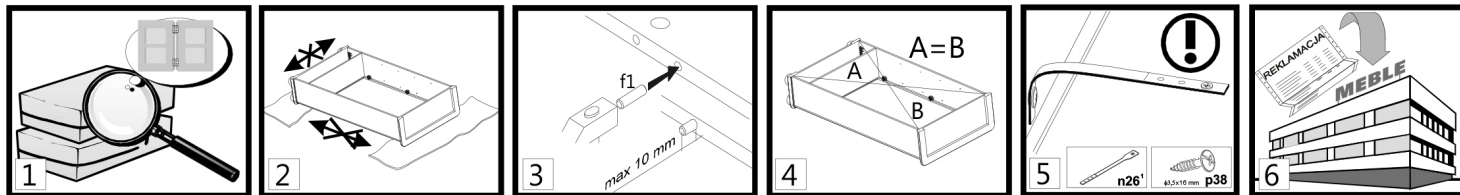



1. POZOR! V montáži nepokračujte, ak sú niektoré komponenty chybné alebo poškodené.
2. Počas montáže položte komponenty na mäkký, čistý povrch, napr. na uterák alebo deku. Nábytok nemontujte na handrách, koberecch atď.
3. Kolíky f1 zasuňte do otvorov s priemerom 8 mm, ktoré sa nachádzajú na okrajoch komponentov. Otvory pre vačkové skrutky nechajte voľné. Každý kolík, ktorý vyčnieva viac ako 10 mm je potrebné vybrať, vymeniť a skrútiť, pretože môže poškodiť bočnú stenu počas montáže.
4. Pred pripevnením zadnej steny sa uistite, že sú uhlopriečky rovnako dlhé.
5. POZOR! Bezpečnostný popruh. Inštalujte podľa pokynov. Nesprávne upevnený nábytok sa môže počas používania uvoľniť a spadnúť.
6. Vážení zákazníci, v prípade reklamácie uveďte kódové číslo uvedené na prvej strane návodu na montáž. Nahlásiť všetky komentáre a reklamácie tam, kde ste nábytok zakúpili. Ak je to možné, poskytnite štítok chybného výrobku s uvedením dátumu balenia a baliarie.



Vysvetlenia/prípadné poznámky použité v návode na montáž:

Symbol komponentu	Kód	Rozmery [mm]	Množstvo [ks]	Balenie	
	A	B	C	D	E

Prvá fáza montáže zahŕňa montáž komponentov so správnym príslušenstvom, ako je špecifikované na nižšie uvedených výkresoch.

-  Symbol  označuje miesta, kde je počas montáže potrebná osobitná opatrnosť.

Nastavovacia skrutka upravuje otváranie dvierok klapky skrinky (utiahnite skrutku, aby dvere klapky skrinky voľnejšie padali). POZNÁMKA!!

-  Nedostatok pre nesprávne nastavenie predstavuje riziko voľného pádu klapky dveri.

POZNÁMKA!!

Po kompletnej zostavení pripevnite jednotku na stenu. Nesprávne pripevnený nábytok sa môže počas montáže alebo používania uvoľniť a spadnúť. Jednotku môže na stenu pripevniť len kvalifikovaná osoba.

-  Predtým skontrolujte, či je stena vhodná na to, aby sa na ňu dal pripevniť nábytok. Vyberte vhodnú kotviacu skrutku a skontrolujte pevnosť a kvalitu upevnenia.

POZNÁMKA!!

Umiestnite hornú jednotku na základnú jednotku a potom ich spojte pomocou spojovacej dosky n52 a skrutiek p25. Ak sa tento pokyn nedodrží, jednotka sa môže počas používania uvoľniť a spadnúť.

-  Zostavte jednotku podľa nižšie uvedených výkresov s použitím určených konektorov a/alebo spojov.

-  POZOR! Úkon sa musí vykonávať veľmi opatrne, aby nedošlo k poškodeniu časti výrobku.

-  Naneste lepidlo y1 do otvorov znázorneného komponentu, pripevnite ho a počkajte, kým lepidlo zaschne.

-  Lepené miesto dôkladne vyčistite.

-  Úprava

-  POZNÁMKA!! So sklenenými komponentmi zaobchádzajte mimoriadne opatrne, aby ste sa neporezali, nepoškodili alebo nerozbili komponenty.

-  Vyvrtajte otvory podľa výkresov. Pri tejto operácii dávajte pozor, aby ste sa neporezali alebo nepoškodili komponent!

-  Uťahnite skrutky e8 tak, aby nevyčnievali nad ráfik.

-  Možnosť

-  Vložku umiestnite na rám hore nohami na miesto určené pre tento komponent pomocou rozloženej hornej jednotky.

-  Pripojte susedné jednotky pomocou spojovacích skrutiek VHS.

-  POZNÁMKA!! Používajte bezpečnostnú pásku, pretože je nevyhnutná na zaistenie bezpečnosti osôb, ktoré používajú váš nábytok.

-  Dvere môžu byť nainštalované na ľavej alebo pravej strane jednotky.

-  POZNÁMKA!! Lôžková jednotka a klapka majú tendenciu pri zatváraní buchnúť. Existuje riziko zranenia.

-  Na viditeľných miestach použite maskovací pás/jednotku.

-  POZNÁMKA!! Nábytok sa môže uvoľniť a spadnúť, ak sa nepoužijú opatrne.

-  POZNÁMKA!! Vysoko lesklé čelá sú pokryté ochrannou fóliou, ktorá sa po zavesení komponentu odstráni. Povrch týchto predných plôch sa môže čistiť až po 4 týždňoch od odstránenia ochrannej fólie.



Prvky príslušenstva určené na vlastný nákup v špecializovaných predajniach.

Používanie a údržba nábytku

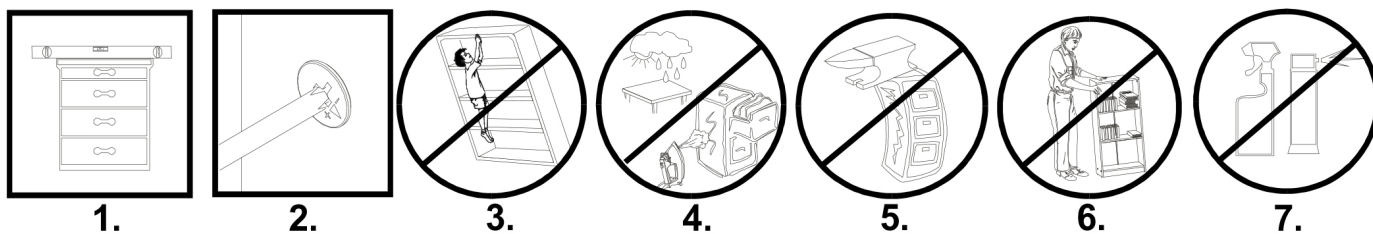

1. Nábytkové jednotky musia byť umiestnené na rovnom povrchu a vyrovnané.
2. Počas používania nábytku skontrolujte stav vačkových čapov. V prípade potreby ich utiahnite.
3. POZNÁMKA!! Nelezte na nábytok
4. Nábytok musí byť umiestnený v suchých miestnostiach s funkčným vetraním a najmenej 1 m od aktívnych zdrojov tepla. Miestnosti musia byť chránené pred nepriaznivými poveternostnými podmienkami (slnčné žiarenie, dážď atď.).
5. POZNÁMKA!! Nadmerné zaťaženie nábytku je pre používateľov nebezpečné a môže spôsobiť trvalé poškodenie.
6. Nábytok sa musí premiestňovať zdvihnutím bez zaťaženia. Poznámka: posunutie alebo ťahanie nábytku môže spôsobiť trvalé poškodenie. Pri premiestňovaní držte vertikálne prvky jednotky, t. j. bočné strany a nohy. Nezachytávajúce vonorovné prvky, napr. konštrukčné police alebo zásuvky, pretože sú náchylné na poškodenie.
7. Nábytok čistíte vlhkou handričkou alebo papierovou utierkou

GRABIE- 1D2W2S

B186-KOM2W1D2S

A	B	C			D	E
1	B186-216	975	405	22	1	1/6
2	B186-209	975	405	22	1	1/6
3	B186-120	1215	405	22	1	1/6
4	B186-121	1215	405	22	1	1/6
5	B186-122	481	379	16	1	1/6
6	B186-311	929	379	16	1	2/6
7	B185-506	928	360	6	1	3/6
8	B186-017	721	460	19	1	2/6
9	B186-018	721	460	19	1	2/6
23	B185-507	440	208	4	1	5/6
11	B185-508	440	395	4	1	4/6
12	B186-019	485	460	19	1	2/6
13	B186-501	350	150	16	2	1/6
14	B186-502	350	150	16	2	1/6
15	B186-509	399	136	16	2	1/6
16	B186-510	64	379	16	2	1/6
17	B186-916	355	415	2,5	2	2/6
19	B186-020	460	241	19	1	2/6
20	B186-021	460	241	19	1	2/6
21	B186-918	730	939	2,5	1	2/6
22	B186-917	493	939	2,5	1	2/6
18	B186-326	928	370	15	1	2/6
24	dodatki				1	6/6

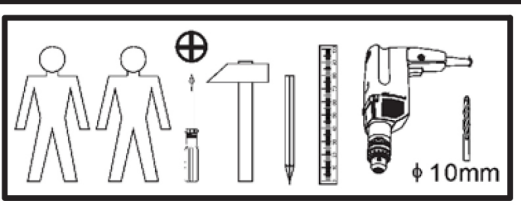
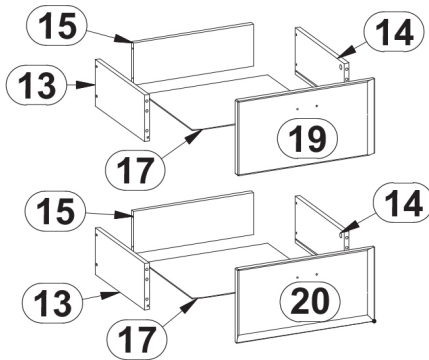
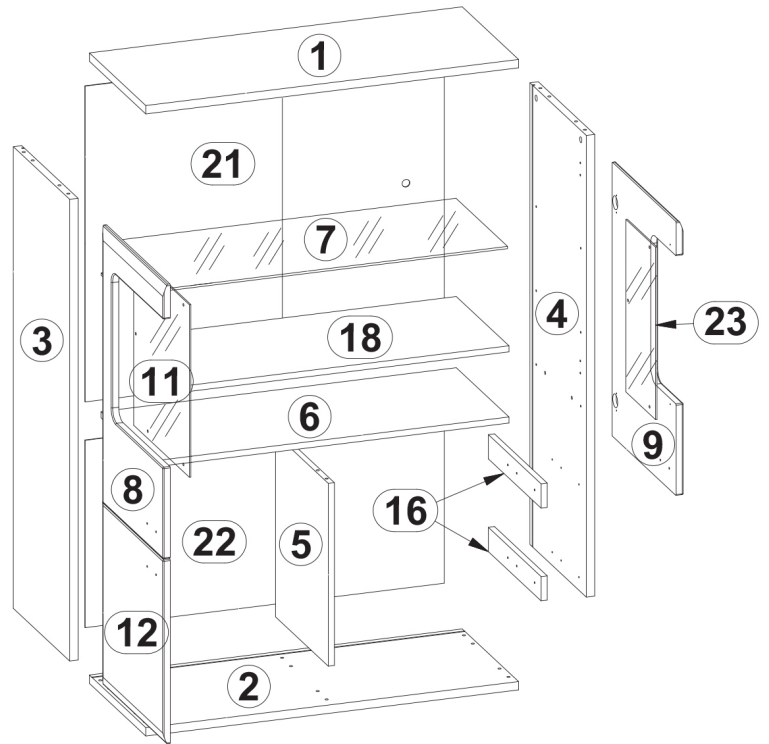
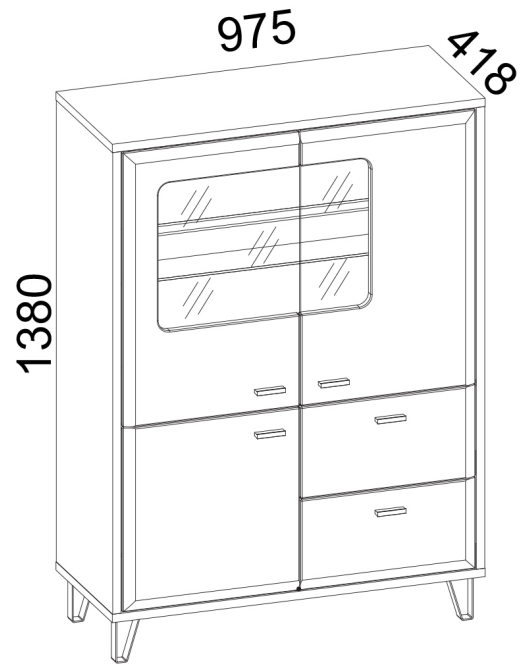

p64	e3	e25	d4	p38	a203	a63	d1
b90	p51	i2	cb6	j8	nb1	z1	f1
r42	r1	s2	e27	n14/2	d3	f35	p17
w117/L	w117/P	s67	o1	n108	r3		

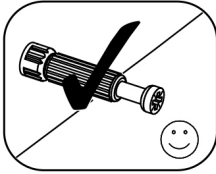
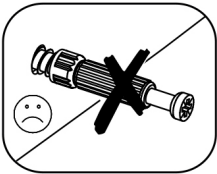
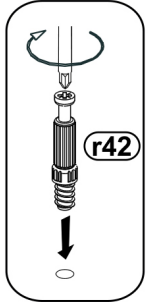
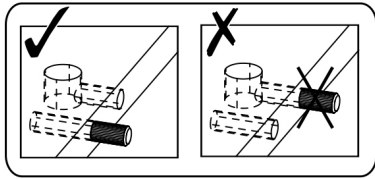
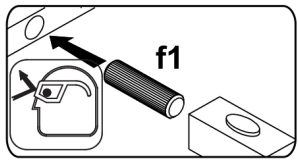

1 §2

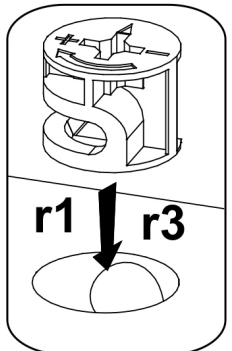
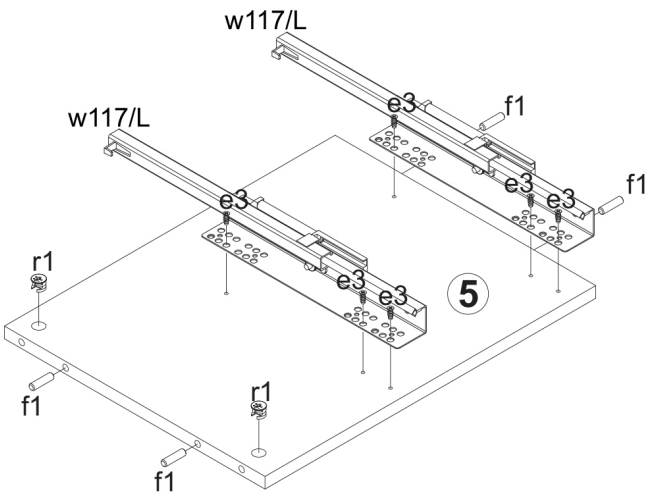
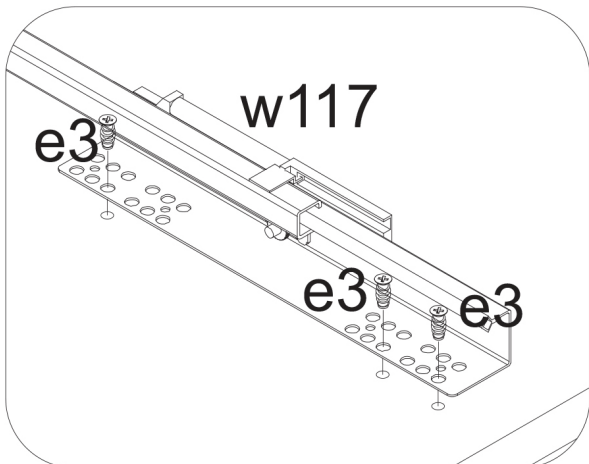
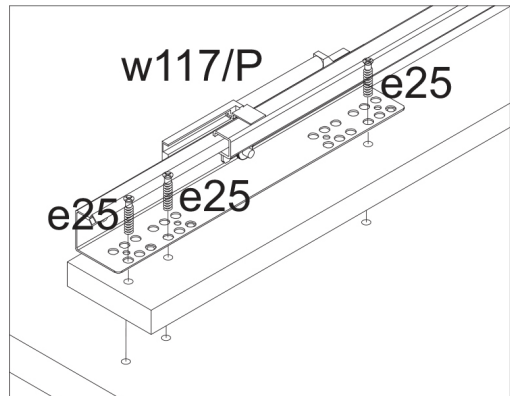
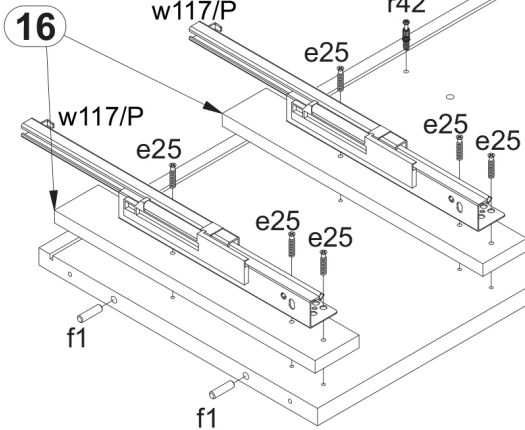
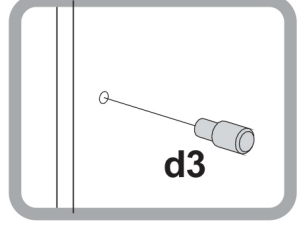
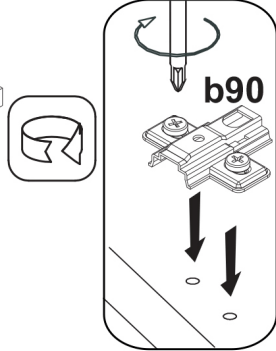
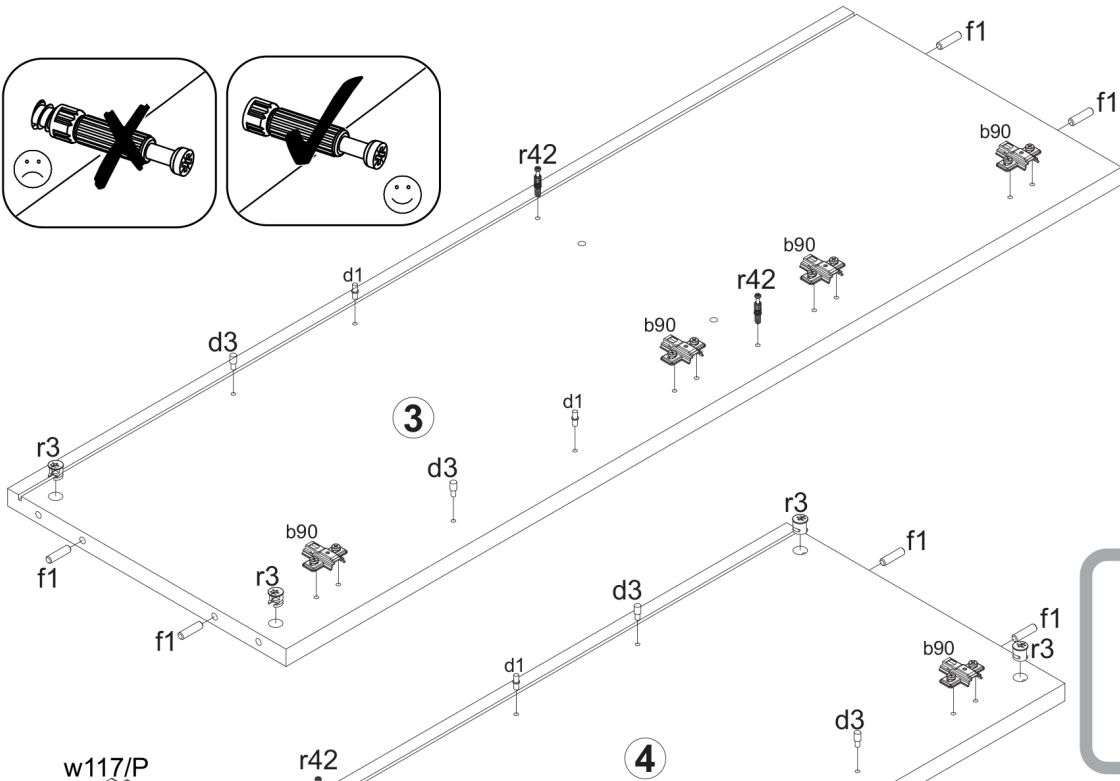

D5mm d3	Ø8x30 mm x4 f1	20/11 x12 r42	x4 b90	Ø15x12 mm #16 x6 r1	x2
	Ø15x15 mm #22 r3	6x28mm x4 e25	x6 w117/P	L-350mm x2	
	D5mm d1	6x13mm x4 e3	x6 w117/L		x2

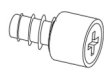
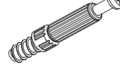

2

$\varnothing 8 \times 30$ mm	$\varnothing 15 \times 12$ mm #16	$\varnothing 6,3 \times 15$ mm	20/11
			
f1	x8 r1	x2 d4	x2 r42 x6

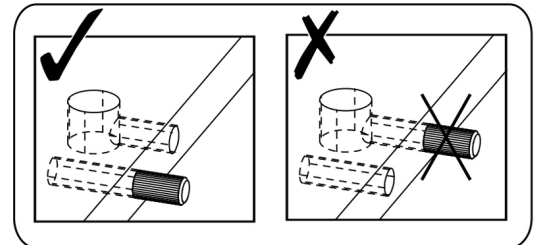
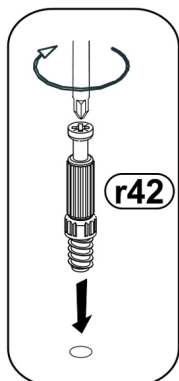
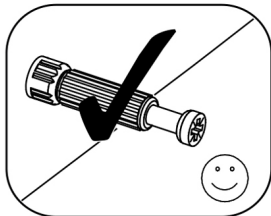
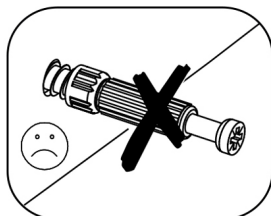
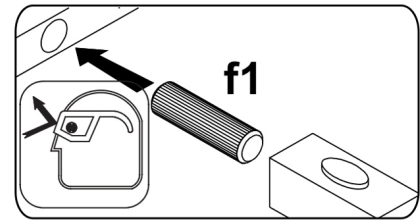
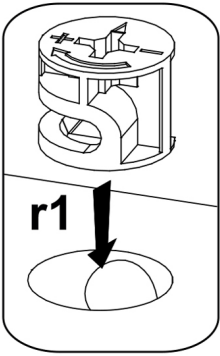
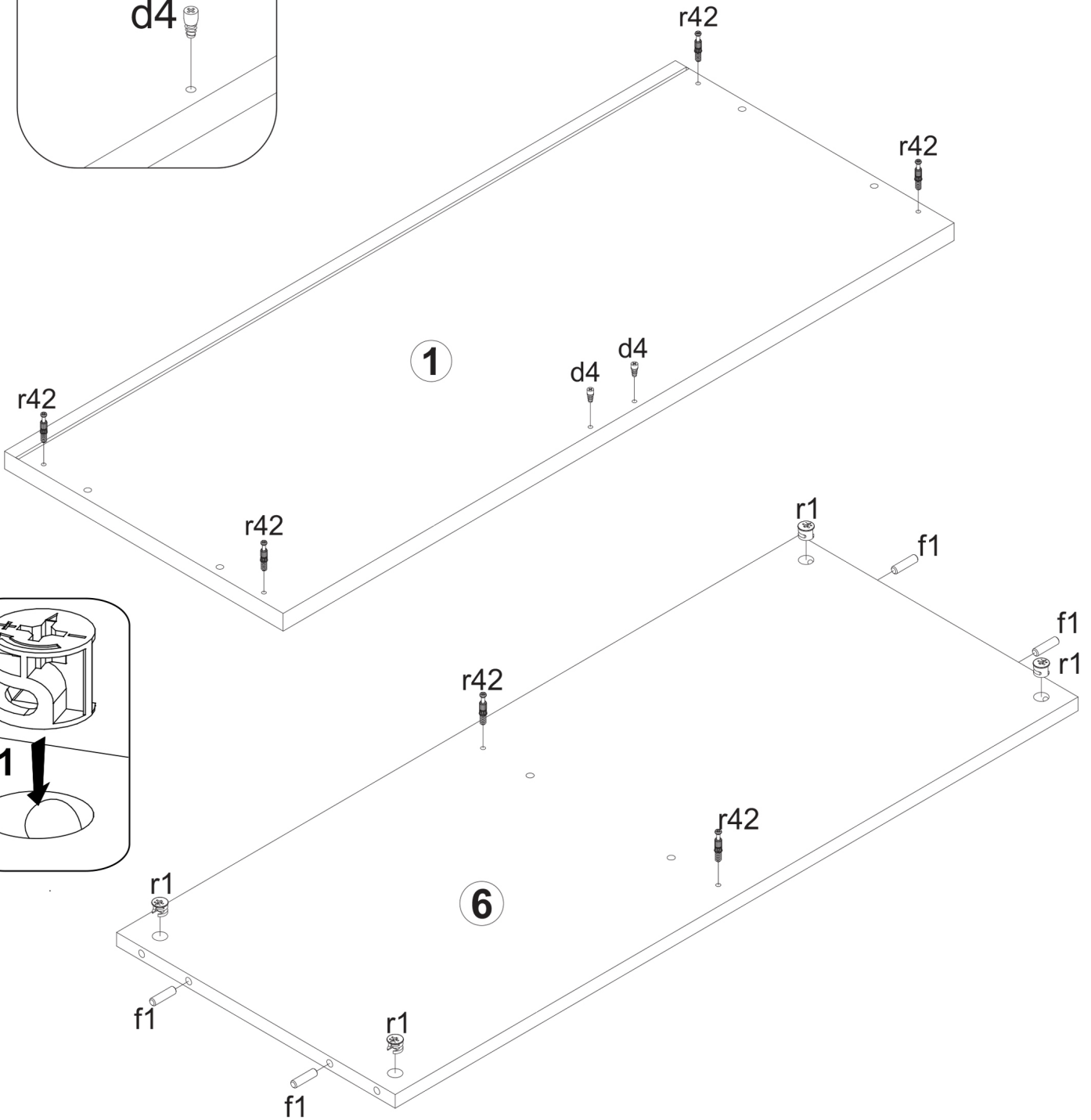
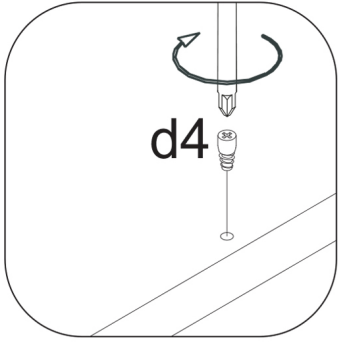

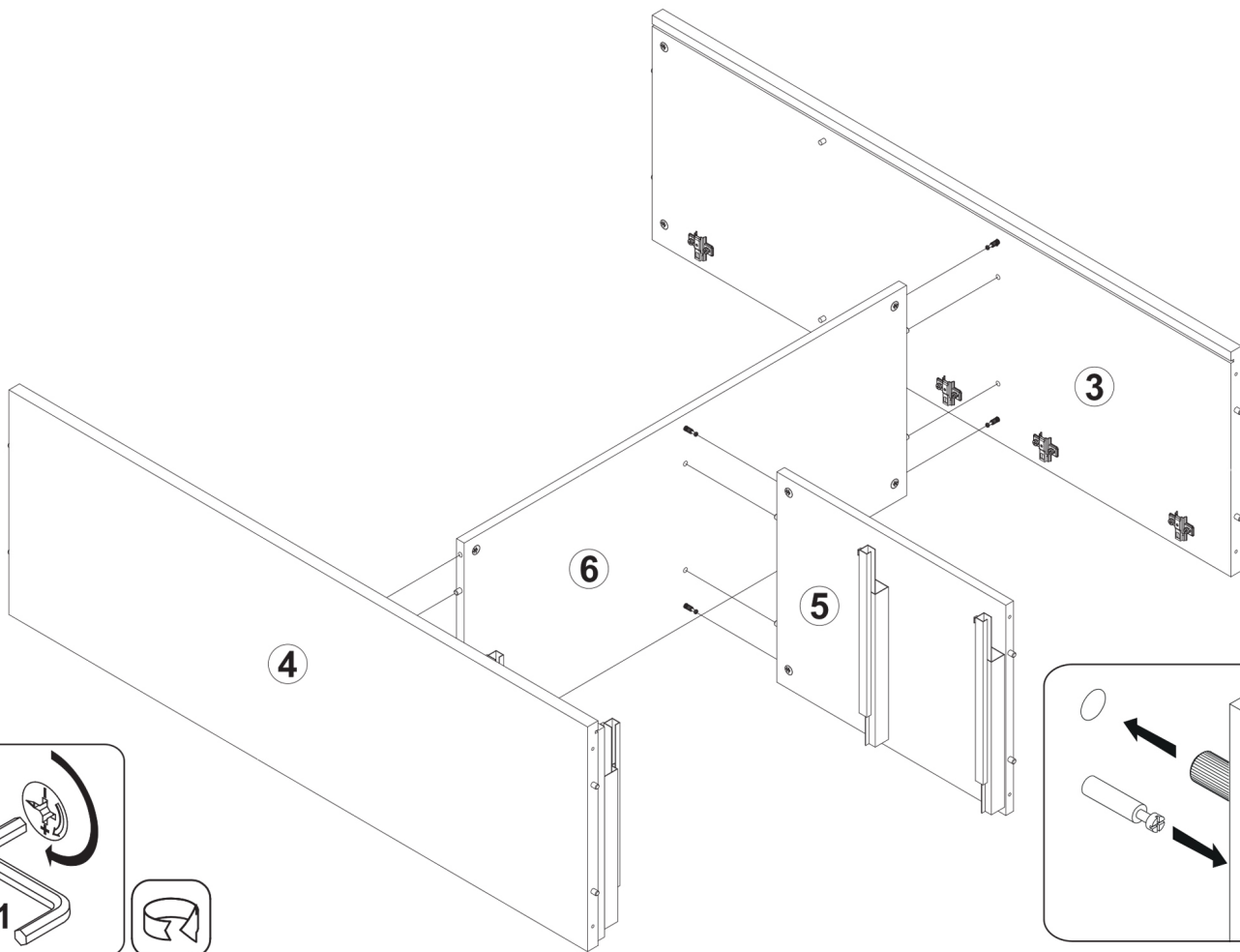

3

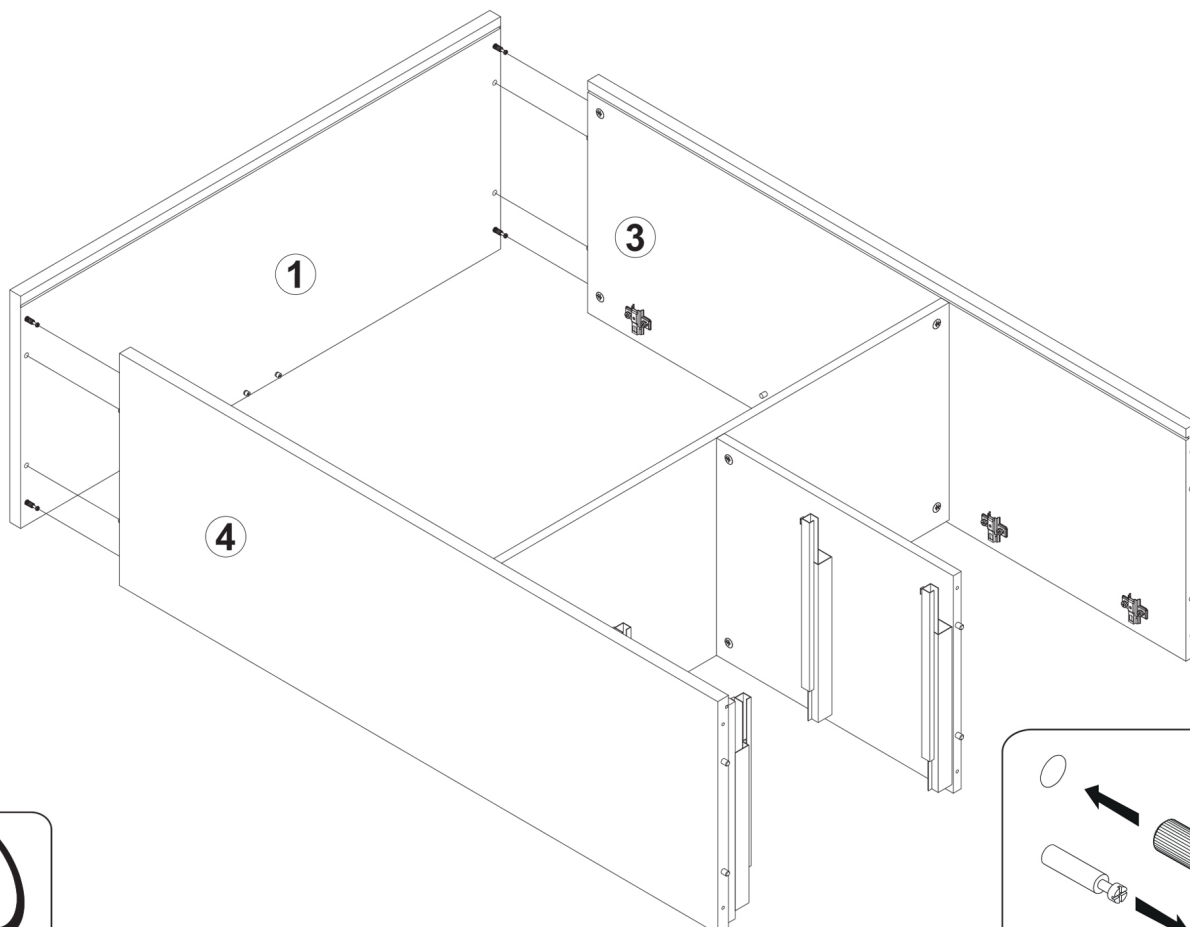

4

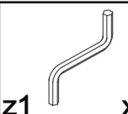

5

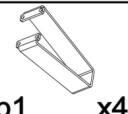
			
z1	x1	e27	x6
		p38	x16
			nb1

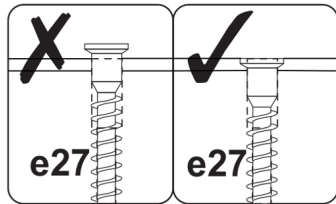
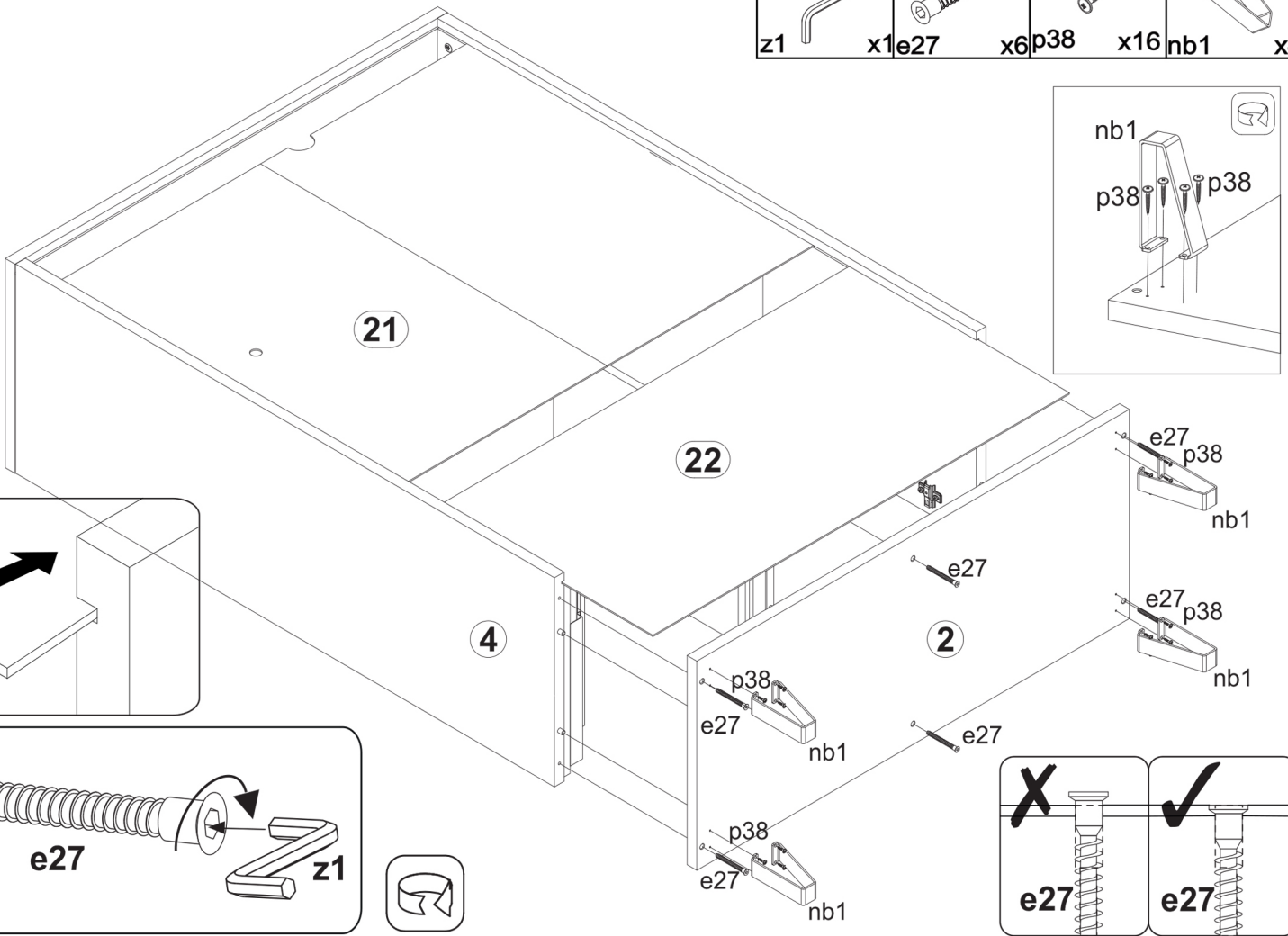
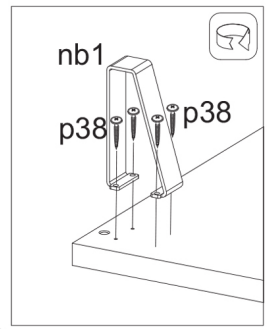
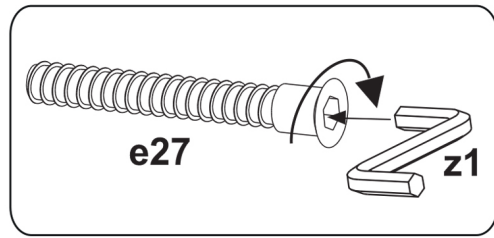
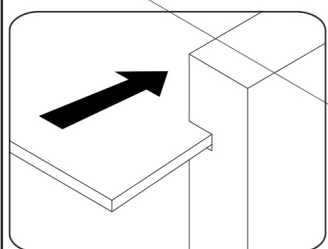

6

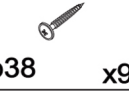
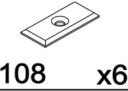
	
p38	x9
	n108
	x6

X = Y

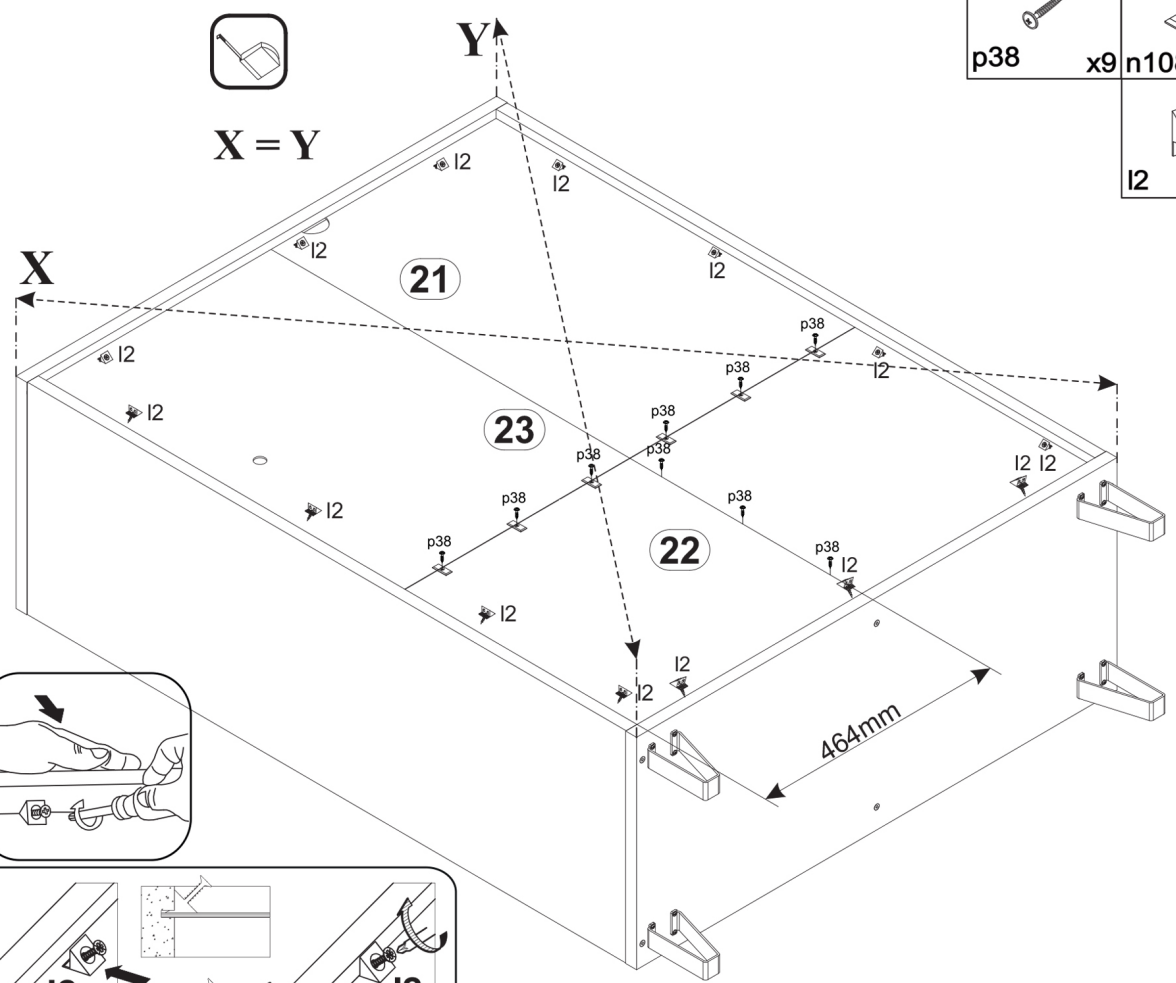
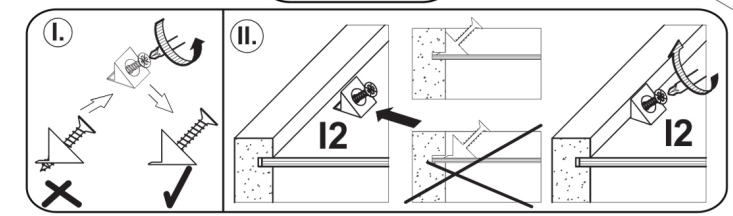
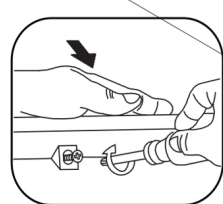
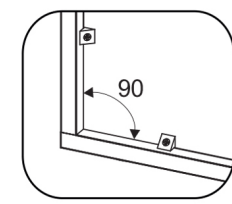
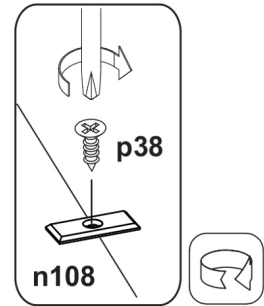

7

64mm cb6 x2	M4x25mm j8 x4	20/11 r42 x8	Ø15x12 mm #16 r1 x8	Ø8x30 mm f1 x4	Ø4x40mm p64 x8	Ø16 s2 x8	x8	Ø3,5x16mm p38 x6	z1 x1
-------------------	---------------------	--------------------	---------------------------	----------------------	----------------------	-----------------	----	------------------------	----------

x2

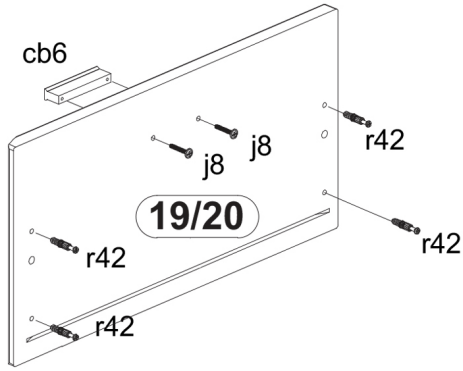

x2

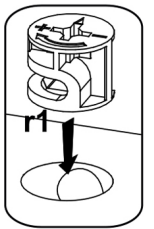
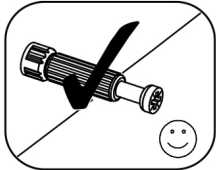
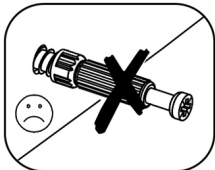
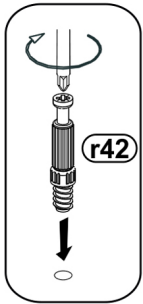
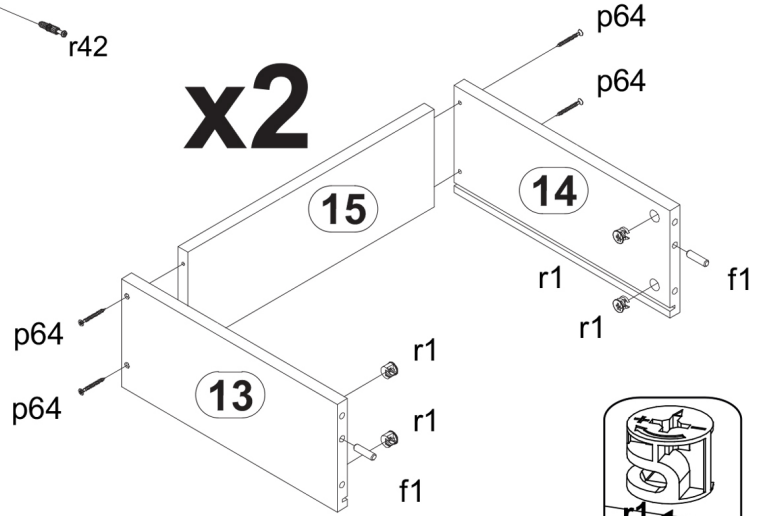

x2

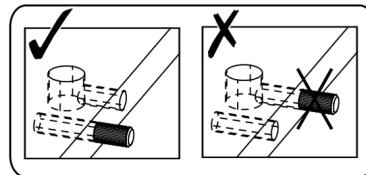
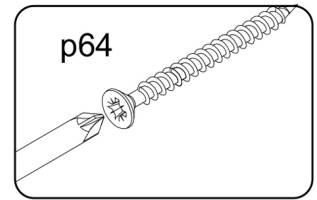
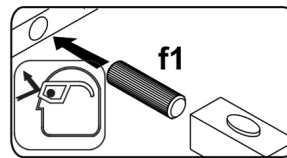
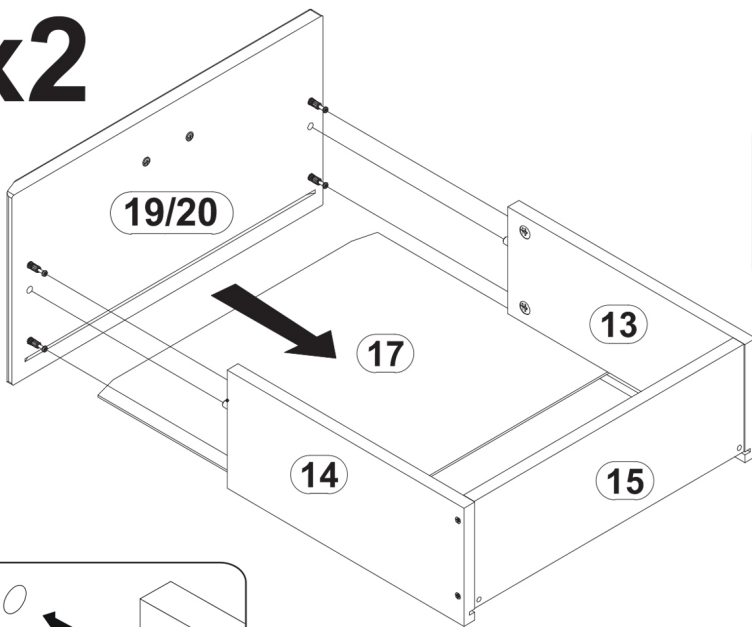

X = Y

x2

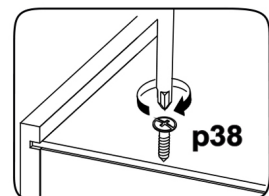
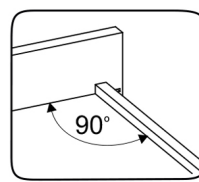
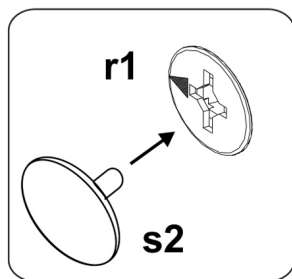
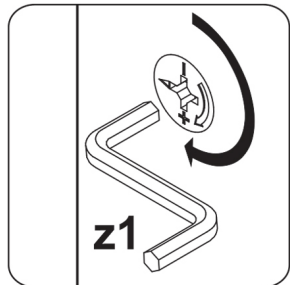
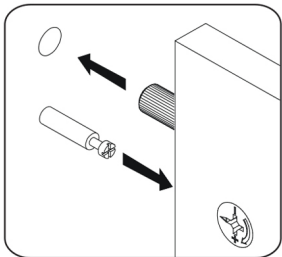
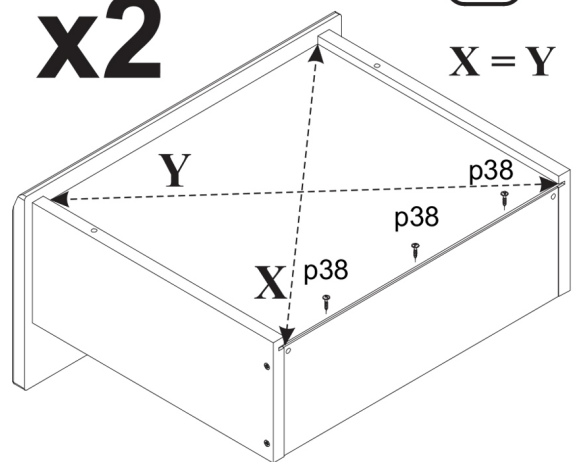

8

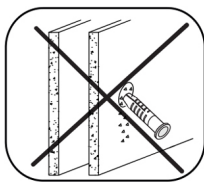
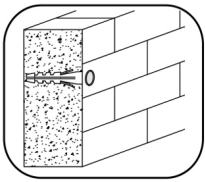

A

$\varnothing 10$

B

f35

C

n14/2

p38

p38

D

n14/2

p17

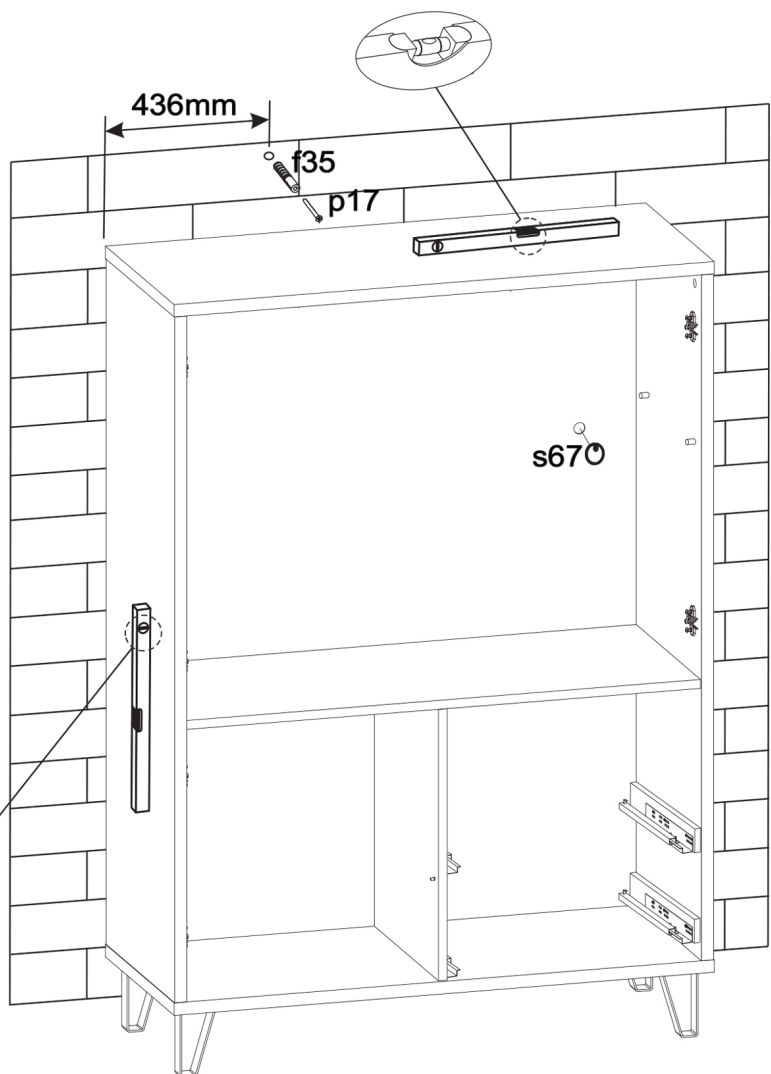
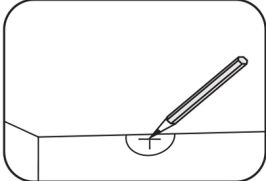

- $\varnothing 3,5 \times 16 \text{mm}$
p38 x2
- 10x50mm
f35 x1
- s67 x1
86x21x15/1,5mm
- n14/2 x1
 $\varnothing 5 \times 50 \text{mm}$
- p17 x1

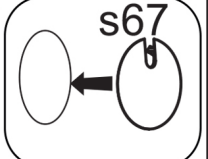

9

18

d1

7

d3

r3/r1

s2

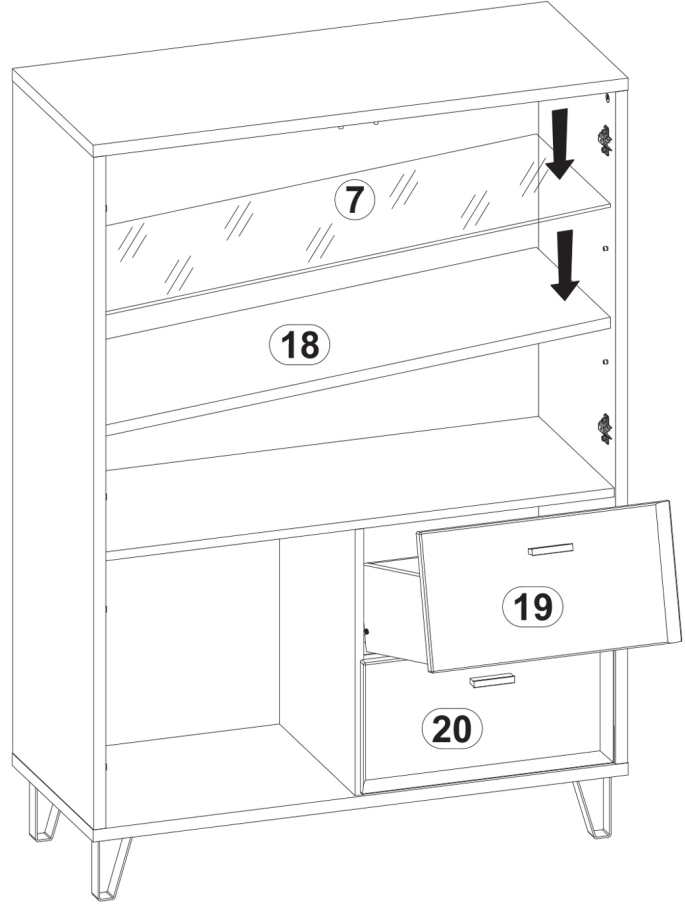

- $\varnothing 16$
s2 x4
- $\varnothing 3,5 \times 16 \text{mm}$
p38 x4

I







II

III

IV

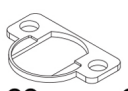
p38

10

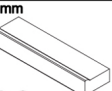
 o1	 p51	 a63	 a203
x8	x12	x6	x6
 p38	 j8	 M4x25mm	 cb6
x8	x8	x6	x3

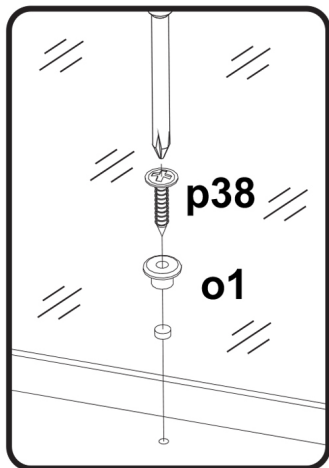
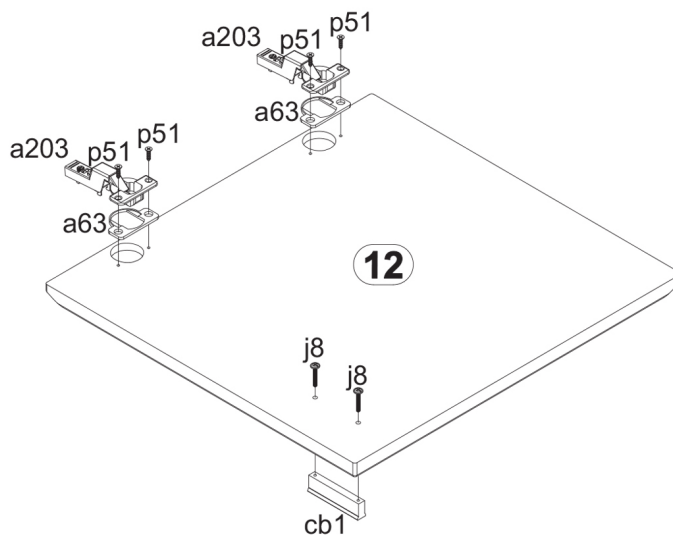
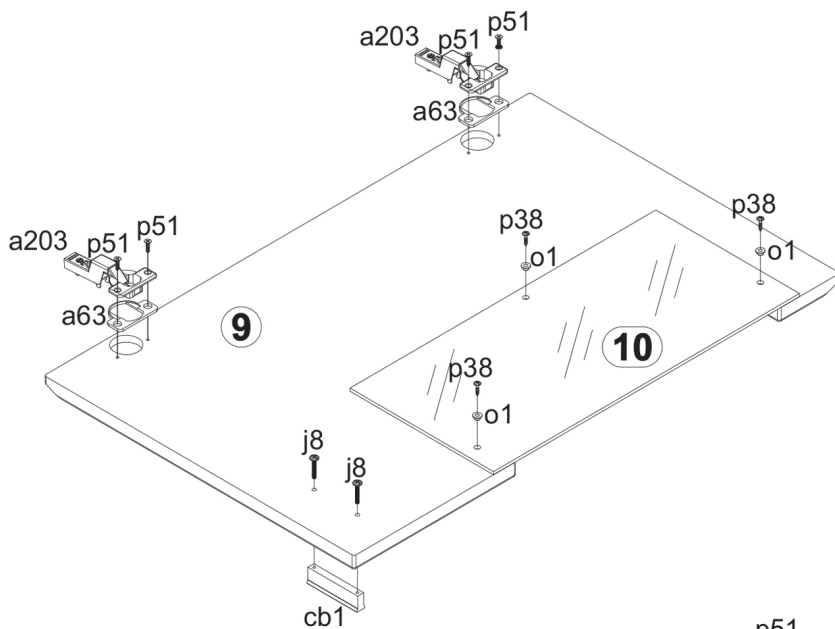
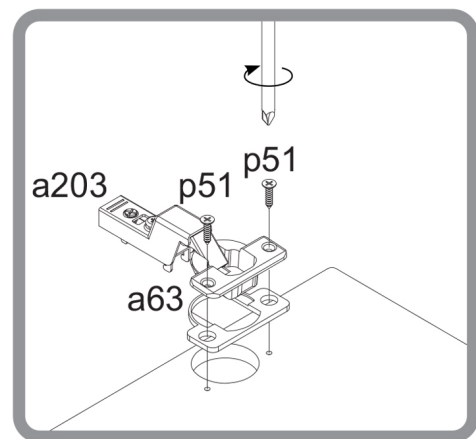
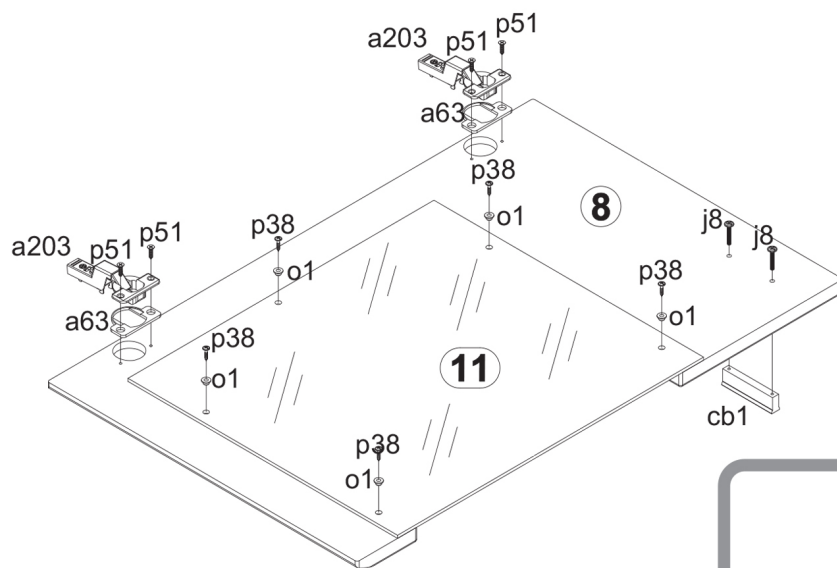

11

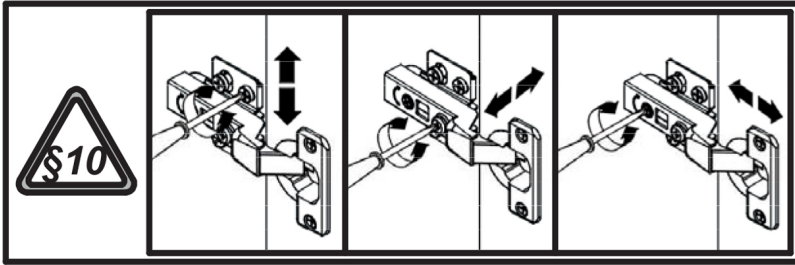
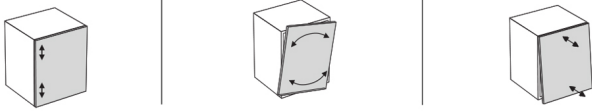
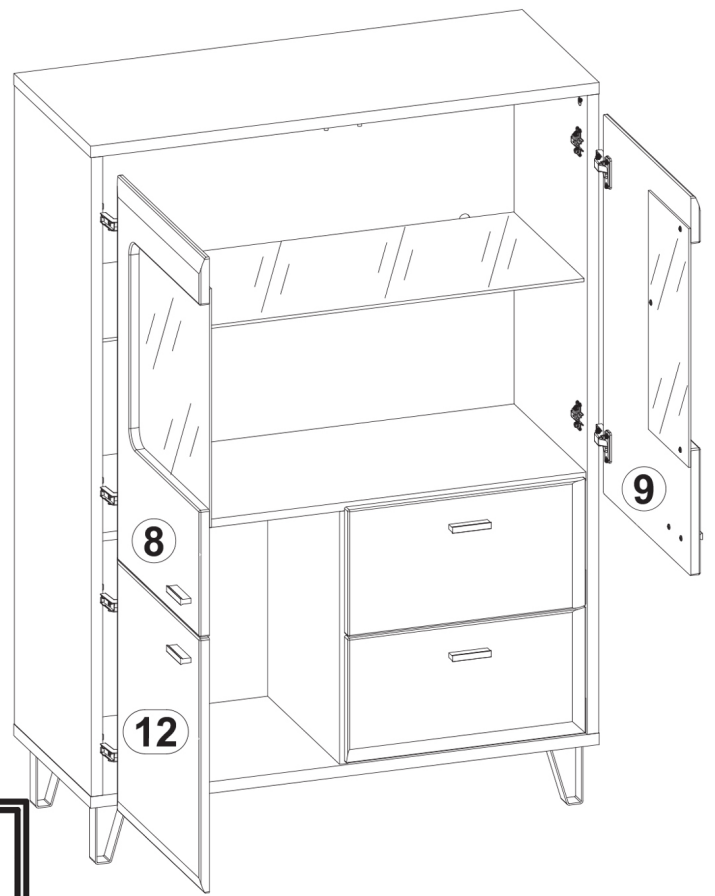
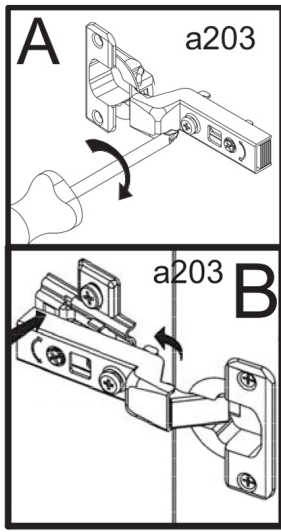

12

